

Application

The EAA-645 airfoil blade acoustical louver provides low static pressure loss and reliable noise reduction over a wide range of frequencies. The EAA-645 is available in a wide array of finishes including custom color matching and is ideally suited for intake or exhaust application on standby generator enclosures.

Standard Construction

Material: Mill finish 6063-T5 extruded aluminum.

Frame: 6" deep × 0.081" thick (152 × 2) channel.

Blades: 45° × 0.081" (2) thick airfoil style with a 26 ga. (0.55) thick perforated backing packed with noncombustible insulating material.

Screen: 1/2" × 0.063" (12.7 × 1.6) expanded and flattened aluminum.

Mullion: Visible.

Minimum Size: 12" × 12" (305 × 305)

Maximum Size: Single section: 60" × 120" (1524 × 3048)
Multiple section: Unlimited

Options

- Factory finish:
 - High Performance Fluoropolymer - 100% resin Newlar®/ 70% resin Kynar®
 - Baked Enamel
 - Clear or Color Anodized, Class 1
 - Prime Coat
- 1 1/2" (38) flange frame.
- Welded construction.
- Alternate bird or insect screens.
- Insulated or non-insulated blank-off panels.
- Filter racks.
- Hinged frame.
- Head and/or sill flashing.

Ratings

Free Area: [48" × 48" (1222 × 1222) unit]: 4.8 ft² (0.45 m²)
30.0%

Performance @ Beginning Point of Water Penetration

Free Area Velocity: 980 fpm (4.98 m/s)
Air Volume Delivered: 4704 cfm (2.22 m³/s)
Pressure Loss: 0.10 in.wg. (25 Pa)

Velocity @ 0.15 in.wg. Pressure Loss: 1200 fpm (6.10 m/s)

Design Load: 30 psf

Acoustical Performance:

Octave Band	2	3	4	5	6	7
Center Freq. (hz)	125	250	500	1000	2000	4000
Transmission Loss	5	5	7	10	12	11
Noise Reduction	11	11	13	16	18	17

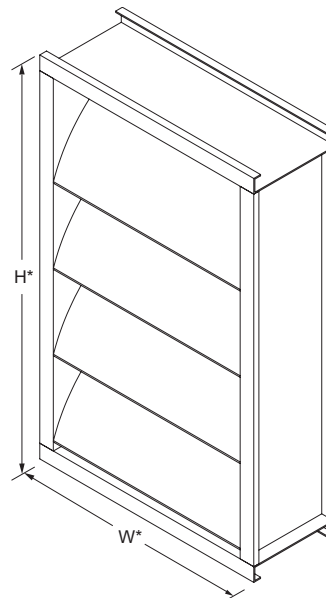

Model **EAA-645**
(standard)

*Louver dimensions furnished approximately 1/2" (13) undersize.

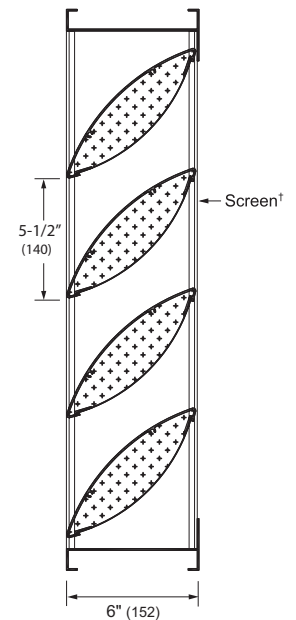

Vertical Section

†Screen adds approximately 3/16" (5) to louver depth.

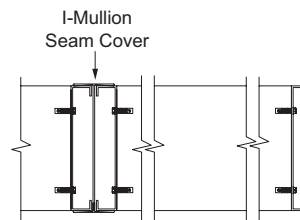

Vertical Mullion
(standard)

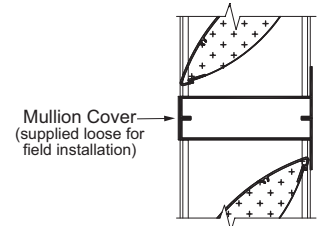

Horizontal Mullion
(standard)

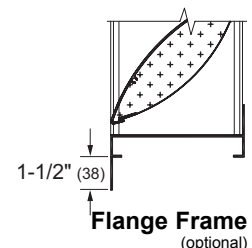

Flange Frame
(optional)

Performance Data

Free Area (ft²)

		Width (Inches)																		
		12	18	24	30	36	42	48	54	60	66	72	78	84	90	96	102	108	114	120
Height (Inches)	12	0.1	0.2	0.2	0.3	0.3	0.4	0.5	0.5	0.6	0.6	0.7	0.8	0.8	0.9	0.9	1.0	1.1	1.1	1.2
	18	0.3	0.4	0.6	0.7	0.9	1.0	1.2	1.3	1.5	1.7	1.8	2.0	2.1	2.3	2.4	2.6	2.7	2.9	3.1
	24	0.4	0.7	0.9	1.2	1.4	1.7	1.9	2.2	2.4	2.7	2.9	3.2	3.4	3.7	3.9	4.2	4.4	4.7	4.9
	30	0.6	0.9	1.3	1.6	2.0	2.3	2.7	3.0	3.3	3.7	4.0	4.4	4.7	5.1	5.4	5.8	6.1	6.5	6.8
	36	0.7	1.2	1.6	2.1	2.5	2.9	3.4	3.8	4.3	4.7	5.1	5.6	6.0	6.5	6.9	7.3	7.8	8.2	8.7
	42	0.9	1.4	2.0	2.5	3.0	3.6	4.1	4.6	5.2	5.7	6.3	6.8	7.3	7.9	8.4	8.9	9.5	10.0	10.5
	48	1.1	1.7	2.3	2.9	3.6	4.2	4.8	5.5	6.1	6.7	7.4	8.0	8.6	9.3	9.9	10.5	11.1	11.8	12.4
	54	1.2	1.9	2.7	3.4	4.1	4.8	5.6	6.3	7.0	7.7	8.5	9.2	9.9	10.6	11.4	12.1	12.8	13.6	14.3
	60	1.4	2.2	3.0	3.8	4.7	5.5	6.3	7.1	7.9	8.8	9.6	10.4	11.2	12.0	12.9	13.7	14.5	15.3	16.1
	66	1.5	2.4	3.4	4.3	5.2	6.1	7.0	7.9	8.9	9.8	10.7	11.6	12.5	13.4	14.4	15.3	16.2	17.1	18.0
	72	1.7	2.7	3.7	4.7	5.7	6.7	7.8	8.8	9.8	10.8	11.8	12.8	13.8	14.8	15.8	16.9	17.9	18.9	19.9
	78	1.8	3.0	4.1	5.2	6.3	7.4	8.5	9.6	10.7	11.8	12.9	14.0	15.1	16.2	17.3	18.4	19.5	20.7	21.8
	84	2.0	3.2	4.4	5.6	6.8	8.0	9.2	10.4	11.6	12.8	14.0	15.2	16.4	17.6	18.8	20.0	21.2	22.4	23.6
	90	2.2	3.5	4.8	6.1	7.3	8.6	9.9	11.2	12.5	13.8	15.1	16.4	17.7	19.0	20.3	21.6	22.9	24.2	25.5
	96	2.3	3.7	5.1	6.5	7.9	9.3	10.7	12.1	13.5	14.8	16.2	17.6	19.0	20.4	21.8	23.2	24.6	26.0	27.4
	102	2.5	4.0	5.5	6.9	8.4	9.9	11.4	1.9	14.4	15.9	17.3	18.8	20.3	21.8	23.3	24.8	26.3	27.8	29.2
108	2.6	4.2	5.8	7.4	9.0	10.5	12.1	13.7	15.3	16.9	18.5	20.0	21.6	23.2	24.8	26.4	27.9	29.5	31.1	
114	2.8	4.5	6.1	7.8	9.5	11.2	12.9	14.5	16.2	17.9	19.6	21.2	22.9	24.6	26.3	27.9	29.6	31.3	33.0	
120	3.0	4.7	6.5	8.3	10.0	11.8	13.6	15.4	17.1	18.9	20.7	22.4	24.2	26.0	27.8	29.5	31.3	33.1	34.8	

Pressure Loss

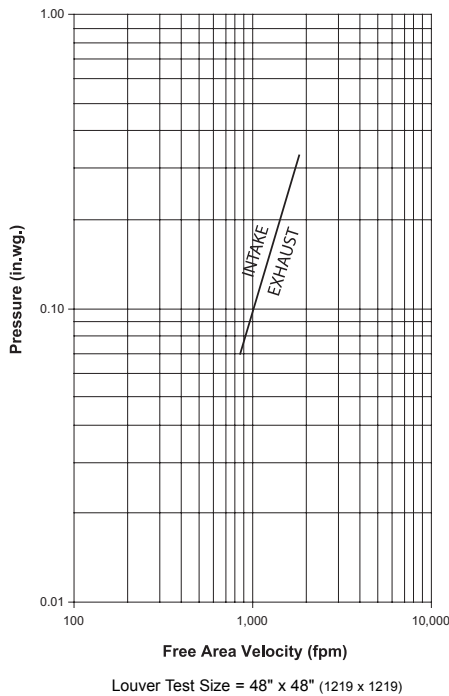

Selection Criteria

Follow the steps listed below to calculate the louver size needed to satisfy the required air volume while minimizing the adverse effects of water penetration and pressure loss.

1. Determine the Free Area Velocity (FAV) at the maximum allowable pressure loss using the *Pressure Loss* chart to the left. While job conditions vary, typically, the maximum allowable pressure loss should not exceed 0.15 in.wg., and the FAV for 0.15 in.wg. pressure loss is listed on the front page of this sheet.
2. **Intake Applications** If the FAV at the Beginning Point of Water Penetration (shown below) is less than the FAV from step 1, then use the FAV at the Beginning Point of Water Penetration in step 3, otherwise use the FAV from step 1.
- Exhaust Applications** Use the FAV from step 1 in step 3.
3. Calculate the total louver square footage required using the following equation.

$$\frac{\text{Required Air Volume (cfm)}}{\text{FAV (fpm)}} = \frac{\text{Required Louver (Free-Area) Size (ft}^2\text{)}}{\text{Size in ft}^2}$$

4. Using the *Free Area* chart above, select a louver width and height that yields a free area ft² greater than or equal to the required louver size calculated in step 3.

Water Penetration

Beginning Point of Water Penetration = 980 fpm

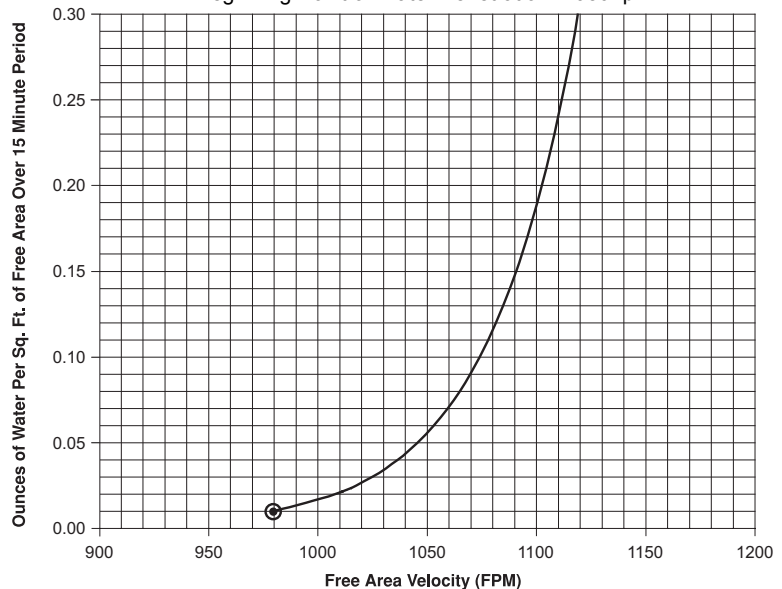

Water Penetration

AMCA defines the beginning point of water penetration as the free area velocity at the intersection of a simple linear regression of test data and the line of 0.01 ounces of water per square foot of free area and is measured through a 48" x 48" louver during a 15 minute period. The AMCA water penetration test provides a method for comparing louver models and designs as to their efficiency in resisting the penetration of rainfall under specific lab conditions. C&S Air Products recommends that intake louvers are selected with a reasonable margin of safety below the beginning point of water penetration in order to avoid unwanted penetration during severe storm conditions.