

## Application

The ECD-545 offers exceptional protection against wind-driven rain under the most severe conditions and is ideally suited for high wind areas or applications that are sensitive to wind-driven rain penetration. The ECD-545 incorporates horizontal blades and is available in a wide array of anodized and painted finishes including custom color matching.

## Standard Construction

**Material:** Mill finish 6063-T5 extruded aluminum.

**Frame:** 5" deep × 0.081" thick (127 × 2) channel.

**Blades:** 45° × 0.063" (1.6) thick horizontal drainable style.

**Screen:** 1/2" × 0.063" (12.7 × 1.6) expanded and flattened aluminum.

**Mullion:** Visible.

**Minimum Size:** 4.5" × 5" (114 × 127)

**Maximum Size:** Single section: 60" × 120" (1524 × 3048)  
120" × 60" (3048 × 1524)  
Multiple section: Unlimited

## Options

- Factory finish:
  - High Performance Fluoropolymer - 100% resin Newlar®/ 70% resin Kynar®
  - Baked Enamel
  - Clear or Color Anodized, Class 1
  - Prime Coat
- Hidden vertical mullion for continuous blade appearance.
- Flange frame:
  - 1 1/2" (38) flange
  - Custom-size flange
  - Stucco flange
  - Glazing frame
- Welded construction.
- Alternate bird or insect screens.
- Insulated or non-insulated blank-off panels.
- Filter racks.
- Hinged frame.
- Head and/or sill flashing.
- Installation hardware:
  - Clip angles
  - Continuous angles
- Burglar bars:
  - Shipped loose
  - Shipped mounted
- Frame closure.

## Ratings

**Free Area:** [48" × 48" (1219 × 1219) unit]: 7.4 ft<sup>2</sup> (0.69 m<sup>2</sup>)  
46.3%

**Performance @ Beginning Point of Water Penetration**

**Free Area Velocity:** Above 1250 fpm (6.35 m/s)

**Air Volume Delivered:** Above 9250 cfm (4.37 m<sup>3</sup>/s)

**Pressure Loss:** 0.24 in.wg. (60 Pa)

**Velocity @ 0.15 in.wg. Pressure Loss:** 980 fpm (4.98 m/s)

**Std. Design Load:** 30 psf

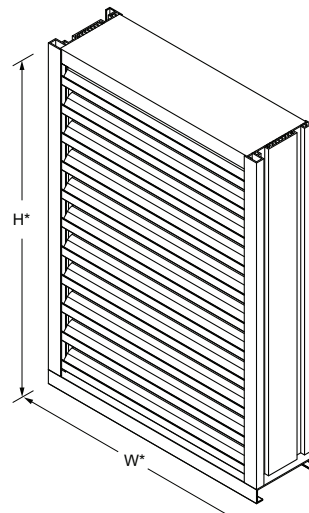

Model **ECD-545**  
(standard)

\*Louver dimensions furnished approximately 1/2" (13) undersize.

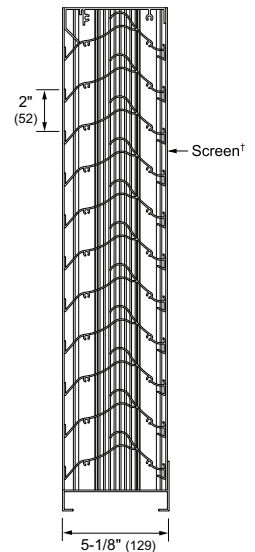

**Vertical Section**

†Screen adds approximately 3/16" (5) to louver depth.

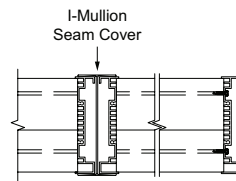

**Visible Vertical Mullion**  
(standard)

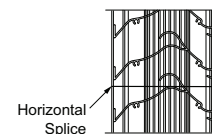

**Horizontal Mullion**  
(standard)

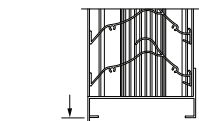

**Flange Frame**  
(optional)

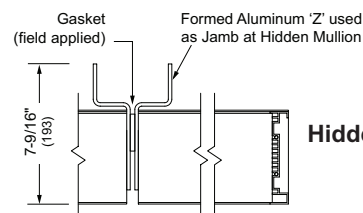

**Hidden Vertical Mullion**  
(optional)

**Free Area (ft<sup>2</sup>)**

		Width (Inches)																			
		4.5	12	18	24	30	36	42	48	54	60	66	72	78	84	90	96	102	108	114	120
Height (Inches)	7	0.02	0.1	0.1	0.1	0.2	0.2	0.3	0.3	0.3	0.4	0.4	0.4	0.5	0.5	0.6	0.6	0.6	0.7	0.7	0.7
	12	0.1	0.3	0.5	0.7	0.8	1.0	1.2	1.4	1.6	1.8	1.9	2.1	2.3	2.5	2.7	2.8	3.0	3.2	3.4	3.6
	18	0.1	0.5	0.8	1.1	1.5	1.8	2.1	2.4	2.7	3.0	3.3	3.6	3.9	4.2	4.6	4.9	5.2	5.5	5.8	6.1
	24	0.2	0.7	1.2	1.6	2.1	2.5	2.9	3.4	3.8	4.3	4.7	5.1	5.6	6.0	6.5	6.9	7.3	7.8	8.2	8.7
	30	0.2	0.9	1.5	2.1	2.7	3.2	3.8	4.4	4.9	5.5	6.1	6.6	7.2	7.8	8.4	8.9	9.5	10.1	10.6	11.2
	36	0.3	1.2	1.9	2.6	3.3	4.0	4.7	5.4	6.1	6.8	7.5	8.2	8.9	9.6	10.3	10.9	11.6	12.3	13.0	13.7
	42	0.3	1.4	2.2	3.0	3.9	4.7	5.5	6.4	7.2	8.0	8.8	9.7	10.5	11.3	12.1	13.0	13.8	14.6	15.5	16.3
	48	0.4	1.6	2.6	3.5	4.5	5.4	6.4	7.4	8.3	9.3	10.2	11.2	12.1	13.1	14.0	15.0	16.0	16.9	17.9	18.8
	54	0.5	1.8	2.9	4.0	5.1	6.2	7.2	8.3	9.4	10.5	11.6	12.7	13.8	14.9	15.9	17.0	18.1	19.2	20.3	21.4
	60	0.5	2.0	3.2	4.5	5.7	6.9	8.1	9.3	10.5	11.8	13.0	14.2	15.4	16.6	17.8	19.1	20.3	21.5	22.7	23.9
	66	0.6	2.2	3.6	4.9	6.3	7.6	9.0	10.3	11.7	13.0	14.4	15.7	17.0	18.4	19.7	21.1	22.4	23.8	25.1	26.5
	72	0.6	2.5	3.9	5.4	6.9	8.4	9.8	11.3	12.8	14.3	15.7	17.2	18.7	20.2	21.6	23.1	24.6	26.1	27.5	29.0
	78	0.7	2.7	4.3	5.9	7.5	9.1	10.7	12.3	13.9	15.5	17.1	18.7	20.3	21.9	23.5	25.1	26.7	28.3	30.0	31.6
84	0.7	2.9	4.6	6.4	8.1	9.8	11.6	13.3	15.0	16.8	18.5	20.2	22.0	23.7	25.4	27.2	28.9	30.6	32.4	34.1	
90	0.8	3.1	5.0	6.8	8.7	10.6	12.4	14.3	16.1	18.0	19.9	21.7	23.6	25.5	27.3	29.2	31.1	32.9	34.8	36.6	
96	0.8	3.3	5.3	7.3	9.3	11.3	13.3	15.3	17.3	19.3	21.3	23.2	25.2	27.2	29.2	31.2	33.2	35.2	37.2	39.2	
102	0.9	3.5	5.7	7.8	9.9	12.0	14.1	16.3	18.4	20.5	22.6	24.8	26.9	29.0	31.1	33.2	35.4	37.5	39.6	41.7	
108	0.9	3.8	6.0	8.3	10.5	12.8	15.0	17.3	19.5	21.8	24.0	26.3	28.5	30.8	33.0	35.3	37.5	39.8	42.0	44.3	
114	1.0	4.0	6.3	8.7	11.1	13.5	15.9	18.3	20.6	23.0	25.4	27.8	30.2	32.5	34.9	37.3	39.7	42.1	44.4	46.8	
120	1.0	4.2	6.7	9.2	11.7	14.2	16.7	19.2	21.8	24.3	26.8	29.3	31.8	34.3	36.8	39.3	41.8	44.3	46.9	49.4	

**Pressure Loss**

(Data corrected to standard air density)

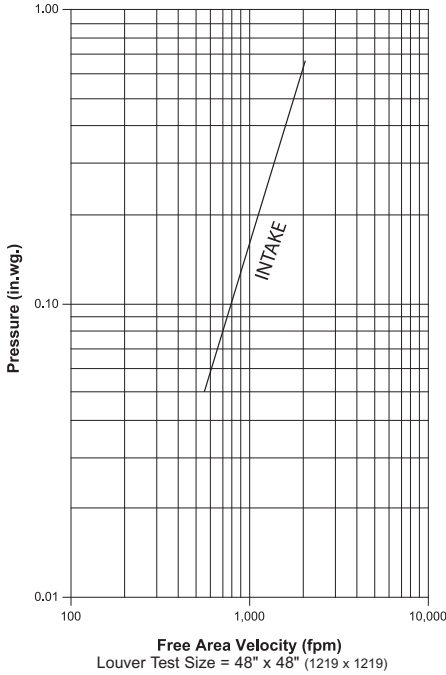

Free Area Velocity (fpm)  
Louver Test Size = 48" x 48" (1219 x 1219)

Pressure loss tested in accordance with Figure 5.5 of AMCA Standard 500-L.

**Water Penetration**

AMCA defines the beginning point of water penetration as the free area velocity at the intersection of a simple linear regression of test data and the line of 0.01 ounces of water per square foot of free area and is measured through a 48" x 48" louver during a 15 minute period. The AMCA water penetration test provides a method for comparing louver models and designs as to their efficiency in resisting the penetration of rainfall under specific lab conditions. C&S Air Products recommends that intake louvers are selected with a reasonable margin of safety below the beginning point of water penetration in order to avoid unwanted penetration during severe storm conditions.

**Wind Driven Rain Performance — AMCA 500-L Wind Driven Rain Test**

Test louver Core Area<sub>i</sub> is 39<sup>3</sup>/<sub>8</sub>" x 39<sup>3</sup>/<sub>8</sub>".

Wind Velocity	Rainfall	Airflow	Core Velocity	Effectiveness Ratio	Wind Class	Discharge Class
29 mph	3 in/hr	9276 cfm	862 fpm	99.4%	A	2
50 mph	8 in/hr	10,502 cfm	975 fpm	95.3%	B	2

Wind Driven Rain <sub>2</sub>		Discharge Loss <sub>3</sub>
Class	Effectiveness	Coefficient
A	1.000 to 0.99	0.4 to 1.000
B	0.989 to 0.95	0.3 to 0.399
C	0.949 to 0.80	0.2 to 0.299
D	0.799 to 0.00	0.0 to 0.199

**NOTES**

1. Core Area is the open area of the louver face (face area less louver frame). 2. Wind Driven Rain Penetration Classes. 3. Discharge Loss Coefficient is calculated by dividing the louvers' actual airflow rate by the theoretical airflow rate for an unobstructed opening. The higher the coefficient the lower the resistance to air flow.

Information is correct at time of printing. However, we reserve the right to make changes without notice.

NOTE: Dimensions in parentheses ( ) are millimeters.

**Selection Criteria**

Follow the steps listed below to calculate the louver size needed to satisfy the required air volume while minimizing the adverse effects of water penetration and pressure loss.

1. Determine the Free Area Velocity (FAV) at the maximum allowable pressure loss using the *Pressure Loss* chart to the left. While job conditions vary, typically, the maximum allowable pressure loss should not exceed 0.15 in.wg., and the FAV for 0.15 in.wg. pressure loss is listed on the front page of this sheet.

2. **Intake Applications** If the FAV at the Beginning Point of Water Penetration (shown below) is less than the FAV from step 1, then use the FAV at the Beginning Point of Water Penetration in step 3, otherwise use the FAV from step 1.

**Exhaust Applications** Use the FAV from step 1 in step 3.

3. Calculate the total louver square footage required using the following equation.

$$\frac{\text{Required Air Volume}}{\text{cfm}} \div \frac{\text{FAV}}{\text{fpm}} = \frac{\text{Required Louver (Free-Area) Size}}{\text{ft}^2}$$

4. Using the *Free Area* chart above, select a louver width and height that yields a free area ft<sup>2</sup> greater than or equal to the required louver size calculated in step 3.

**Water Penetration**

Beginning Point of Water Penetration = Above 1250 fpm

