

The following installation details apply to model **FSD-381, and FSD-382**

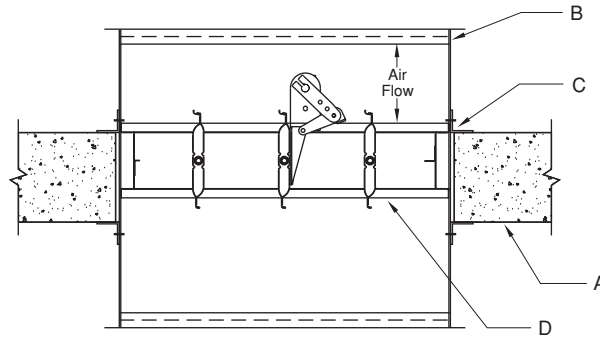

Horizontal Mount

- A.** Concrete or masonry fire partition shown. The opening shall be a minimum of 1/4" (6) with a maximum of 3/4" (19) larger than the overall damper and sleeve assembly size. When openings are larger than 3/4" (19), but less than or equal to 6" (152), the mounting angles must be a minimum of 16 gauge (1.5) and must be wide enough to overlap the opening by a minimum of 1" (25). Damper must be installed with leading edge of closed blade within the partition.
- B.** For rigid type duct connections, the sleeve shall be a minimum of 16 gauge (1.5) for dampers up to 36" wide by 24" high (914 x 610) and a minimum of 14 gauge (1.9) for larger units. When lighter gauge sleeves are used, one or more of commonly used breakaway style connections are required. Refer to Sleeve Termination Supplemental Installation Instructions for further details. In no case will the sleeve gauge be less than the duct gauge to which it is connected. Damper sleeve shall not extend more than 6" (152) beyond the rated partition unless an access door or Smoke Detector is installed in the sleeve which then permits the extension to be a maximum of 16" (406).
- C.** Mounting angles shall be a minimum 1-1/2" x 1-1/2" x 16 gauge (38 x 38 x 1.5). Fastening or welding angles together at the corners is not required. The angles shall be attached to the sleeve, not the partition, with minimum 3/16" (4.8) diameter steel rivets, Quick-Lock Joints, welds, No. 10 (M5) bolts or sheet metal screws at 6" (152) o.c. maximum. A minimum of two connections per side, top and bottom, with fastener spacing staggered top to bottom. Mounting angles shall overlap the floor a minimum of 1" (25). A minimum 3/4" x 20 gauge (19 x 1) flange termination may be used in lieu of mounting angles. Refer to Sleeve Termination Supplemental Installation Instructions for further details. Ensure that attachment device does not interfere with the operation of the damper and the free movement of the damper blades.

Note: If optional sealing between the retaining angle (or flange) leg and the surface of the partition or floor, and/or between the retaining angle leg and the surface of the damper sleeve is required, the following sealants may be used: Dow-Corning 732 or GE RTV 108 or SCS 1201 RTV. These sealants should be applied such that they do not intrude into the annular space between the outside surface of the damper sleeve and the opening of the partition, floor, into which the damper/sleeve is being installed. Annular space between damper/sleeve and opening shall not be filled with firestop materials such as fill, void or cavity materials.

- D.** When joining multiple sections or fastening the damper to the sleeve, the damper shall be fastened with minimum 3/16" (4.8) diameter steel rivets, Quick-Lock joints, welds, No.10 (M5) bolts or sheet metal screws at 6" (152) o.c. maximum. There must be a minimum of two connections per side top and bottom, and the fastener spacing must be staggered top to bottom. For dampers more than one section wide, a minimum 14 gauge x 5" wide (1.9 x 127) supplemental steel mullion is required. The mullion must be the same length as the opening/duct height, and must be installed between adjacent damper frames running parallel to the opening/duct height. The support mullion must be attached to the damper frames using any of the same fasteners indicated previously in this section. See Support Mullion Placement Diagram below.
- E.** A continuous bead of Dow-Corning 700 or 732, or GE RTV 108 or SCS 1201 RTV silicone rubber sealant shall be applied between the damper and the sleeve and between sections of a multiple damper assembly. Sealant is only required on one side of the damper.
- F.** Fire/Leakage rated dampers and qualified operators are tested together by Underwriters Laboratories and are factory installed to qualify for standard damper/operator warranties. Damper operator/actuator must be tested prior to system start-up to ensure proper operation. Before applying power to the operator/actuator, the power must be verified.

DUCT SIZES	GALVANIZED STEEL
	HORIZONTAL
Maximum Single Section	32" x 48" (813 x 1219)
Maximum Multiple Section	64" x 96"* (1626 x 2438)
Minimum	8" x 8" (203 x 203)

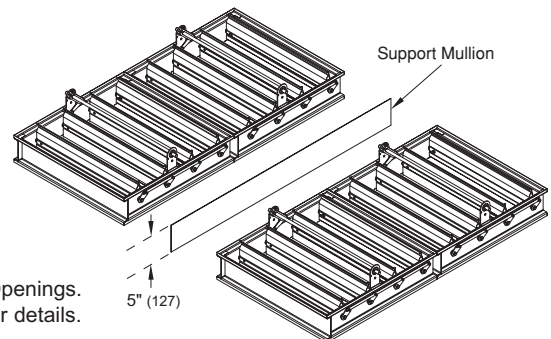

*Individually sleeved dampers can be installed in partitions wider than the maximum U.L. multiple section size using the Support Mullion for Oversized Floor Openings. See Support Mullion for Oversized Floor Openings Installation Instructions for further details.

Underwriter's Laboratories file #R14981. City of New York listing #MEA 295-98-E. The product is also listed by CSFM File # 3225-1404:110 and 3230-1404:111 and conforms to NFPA 90A and NFPA 92A.

Support Mullion Placement Diagram

Information is subject to change without notice or obligation.

NOTE: Dimensions in parentheses () are millimeters.